

MIRO

Porte finition chêne blanc
White oak design door

PREMIUM MIRO



Collection PREMIUM, porte battante montée sur ébrasement, modèle MIRO chêne blanc, accompagnée d'une poignée assortie finition chrome, chêne blanc.

PREMIUM collection, door gone up on frame model MIRO white oak, accompanied with a matched handle model finish chrome-plates, white oak.

Info technique page 80

MIRO

Porte finition chêne clair
Clear oak design door

Collection PREMIUM, porte battante montée sur ébrasement, modèle MIRO chêne clair, accompagnée d'une poignée assortie finition chrome, chêne clair.

PREMIUM collection, door gone up on frame model MIRO clear oak, accompanied with a matched handle model finish chrome-plates, clear oak.

info technique page 80





MIRO

Porte finition chêne gris
Gray oak design door

Collection PREMIUM, porte battante montée sur ébrasement, modèle MIRO chêne gris, accompagnée d'une poignée assortie finition chrome, chêne gris.

PREMIUM collection, door gone up on frame model MIRO gray oak, accompanied with a matched handle model finish chrome-plates, gray oak.

info technique page 80

MIRO

Porte finition wengé
Wenge design door



Collection PREMIUM, porte battante montée sur ébrasement, modèle MIRO wengé, accompagnée d'une poignée assortie finition chrome, wengé.

PREMIUM collection, door gone up on frame model MIRO wenge, accompanied with a matched handle model finish chrome-plates, wenge.

info technique page 80



MIRO

Porte finition chêne cendré
Ashen oak design door

Collection PREMIUM, porte battante montée sur ébrasement, modèle MIRO chêne cendré, accompagnée d'une poignée assortie finition chrome, chêne cendré.

PREMIUM collection, door gone up on frame model MIRO ashen oak, accompanied with a matched handle model finish chrome-plates, ashen oak.

info technique page 80



Collection DESIGN

Valorisez vos portes avec les poignées de la gamme REVILO .

Poignée de porte en Zamak / Zamack door handle.

Vérone
finition satin chrome

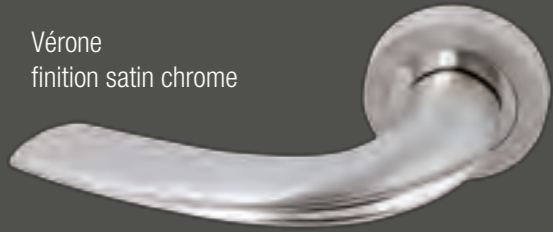

Monza
finition satin nickel



Livourne
finition satin nickel

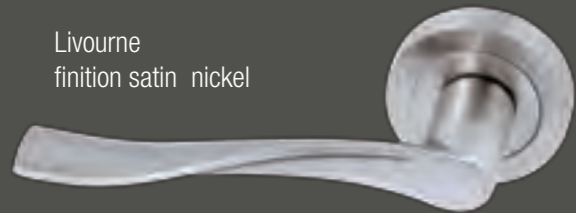

Rome
finition chrome



Imola
finition chrome



Capri
finition satin nickel

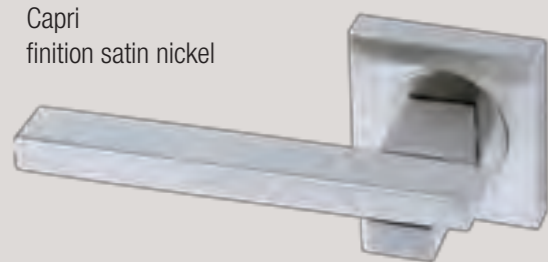

Bergame
finition satin nickel

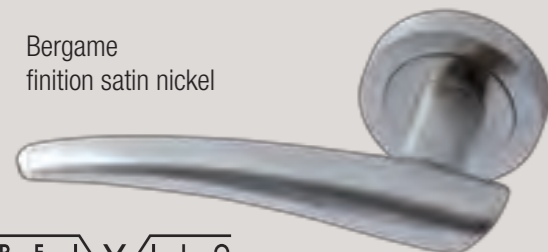

Syracuse
finition satin nickel

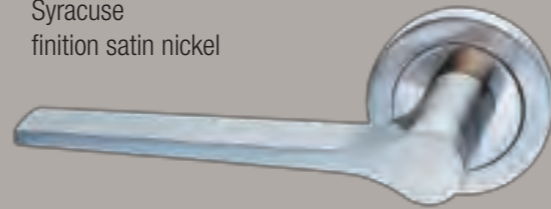

Pérouse
finition satin acajou

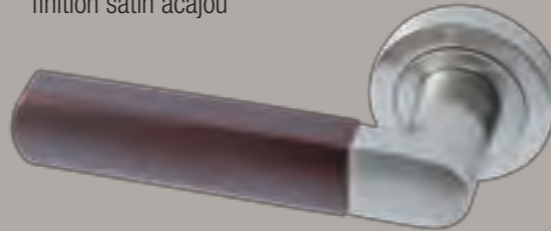

clé / key cylindre / cylinder clé / key cylindre / cylinder



condamnation / toilet condamnation / toilet

Trieste
finition satin nickel

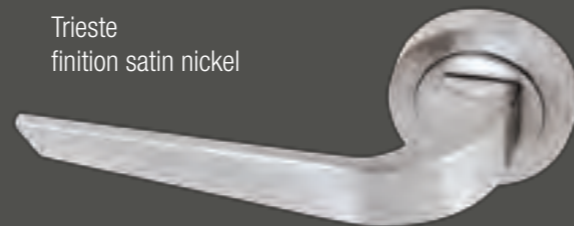

Ancône
finition satin nickel

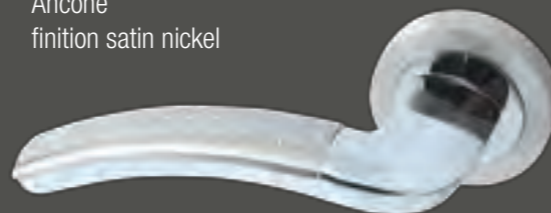

Florence
finition satin nickel

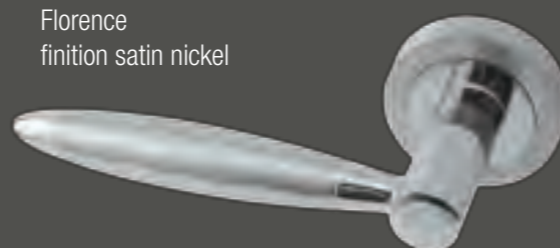

Collection PREMIUM

Poignées de porte en zamak. Finition chrome, décor assorti aux portes PREMIUM.

Zamack door handle. Chrome finish with a matched PREMIUM door decor.



PREMIUM
chrome, chêne blanc / chrome, white oak

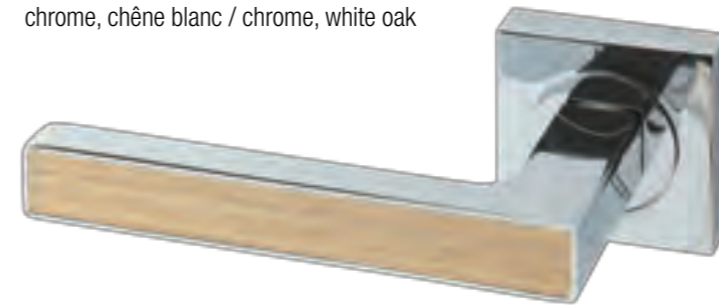

PREMIUM
chrome, chêne clair / chrome, clear oak

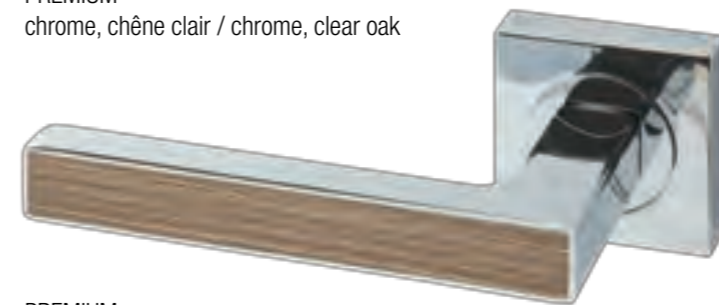

PREMIUM
chrome, chêne gris / chrome, gray oak

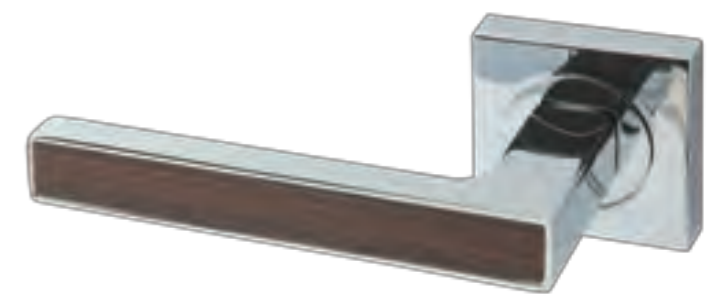

PREMIUM
chrome, wengé / chrome, wenge

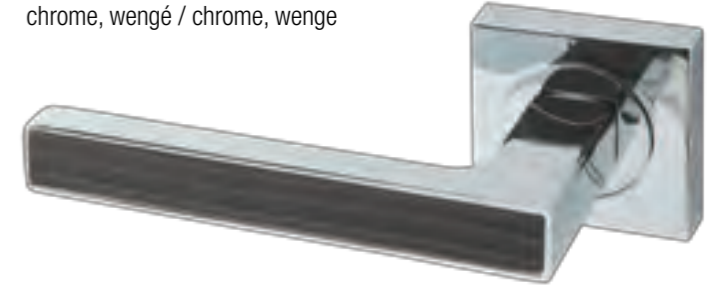

PREMIUM
chrome, chêne cendré / chrome, ashen oak



PREMIUM
chrome, strass / chrome, strass

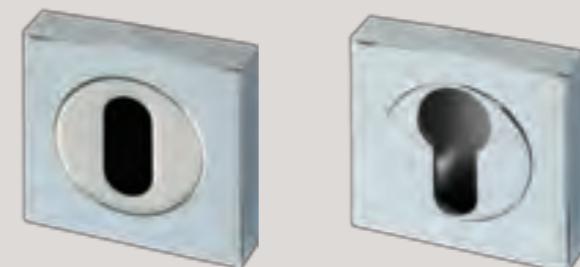

clé / key cylindre / cylinder

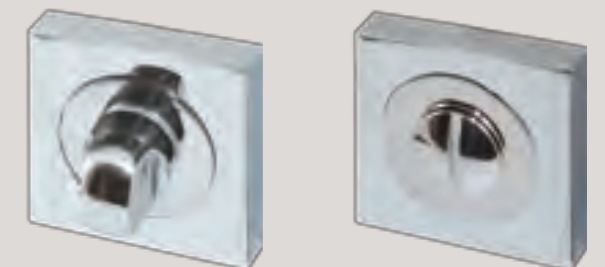

condamnation / toilet

poignées

Données techniques

Technical data

Collection PREMIUM Collection FLAT FLAT collection PREMIUM collection

DESCRIPTIF PORTE BATTANTE								
centimètres	FLAT 73	FLAT 83	FLAT PFC 73	FLAT PFC 83	FLAT PFC 93	PREMIUM 73	PREMIUM 83	PREMIUM 93
Largeur de porte	oui	oui	oui	oui	oui	oui	oui	oui
Porte simple	oui	oui	oui	oui	oui	oui	oui	oui
Porte double	oui	oui	non	non	non	non	non	non
Rive droite en bloc porte	non	non	oui	oui	oui	oui	oui	oui
Rive droite en porte nue	oui	oui	oui	oui	oui	oui	oui	oui
Recouvrement en bloc porte	oui	oui	non	non	non	non	non	non
Recouvrement en porte nue	oui	oui	non	non	non	non	non	non
Réversibilité de la porte	non	non	oui	oui	oui	oui	oui	oui

DOOR FRAME DESCRIPTION								
inches	FLAT 28,7	FLAT 32,7	FLAT PFC 28,7	FLAT PFC 32,7	FLAT PFC 36,6	PREMIUM 28,7	PREMIUM 32,7	PREMIUM 36,6
Width of door	yes	yes	yes	yes	yes	yes	yes	yes
Simple door	yes	yes	yes	yes	yes	yes	yes	yes
Dual door	yes	yes	no	no	no	no	no	no
Straight edge door frame	no	no	yes	yes	yes	yes	yes	yes
Straight edge door	yes	yes	yes	yes	yes	yes	yes	yes
Rebate edge door frame	yes	yes	no	no	no	no	no	no
Rebate edge door	yes	yes	no	no	no	no	no	no
Reversible door frame	no	no	yes	yes	yes	yes	yes	yes

Collection PREMIUM modèle LIBERTO finition prépeinte à peindre ou tapisser pour un rendu invisible. (voir page 4-5)

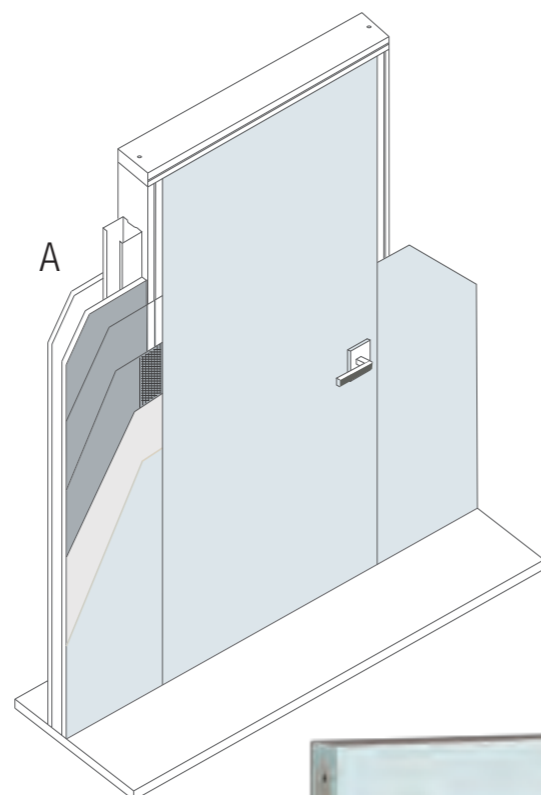
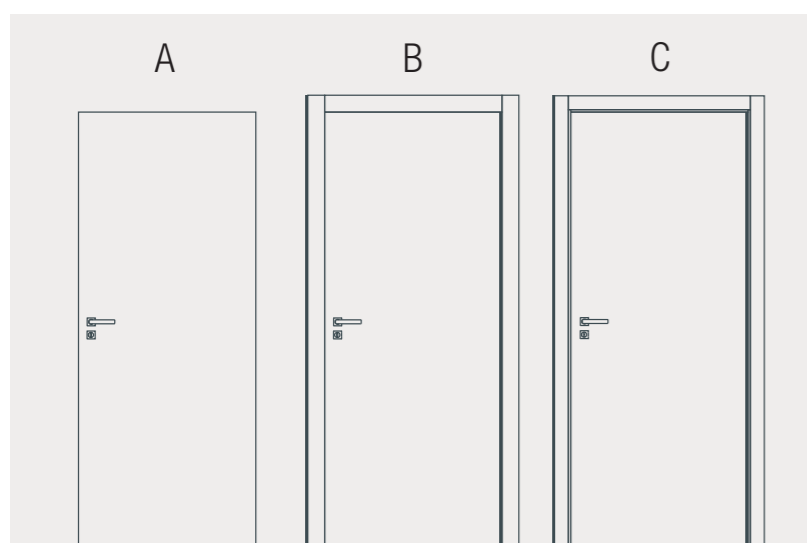

serrure magnétique

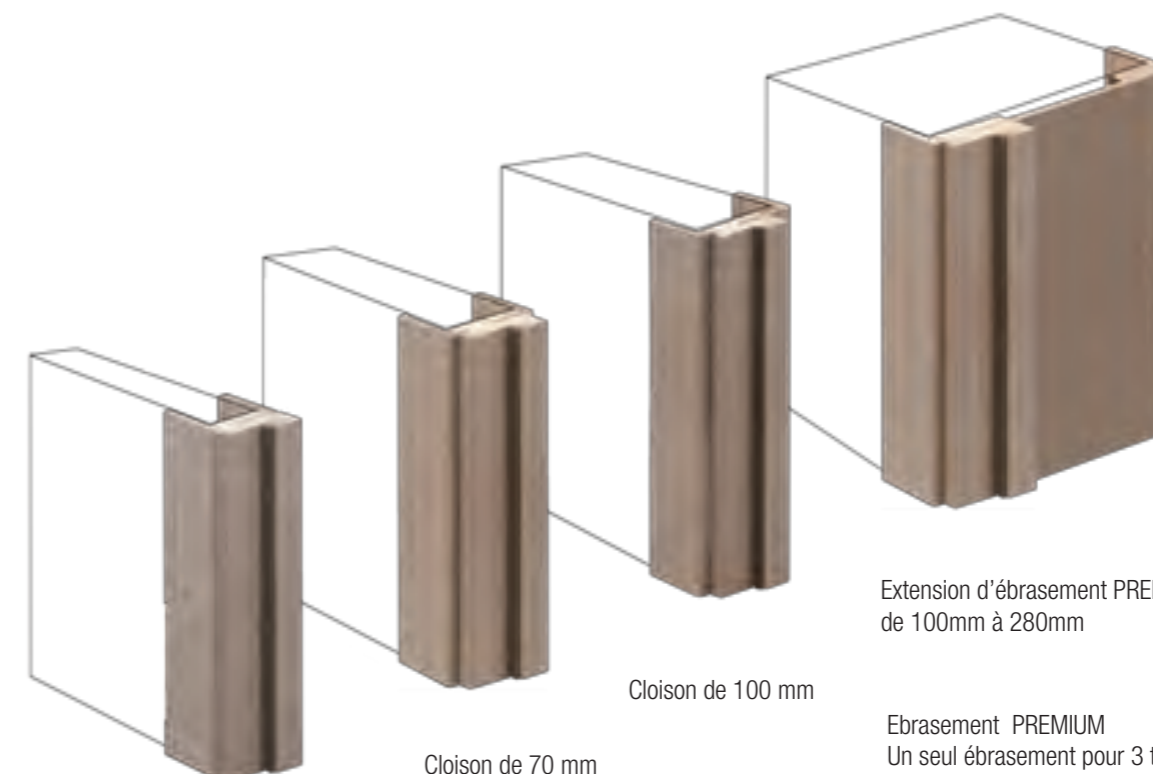
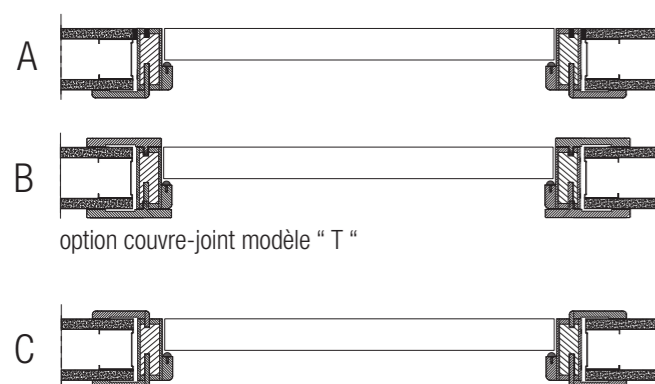

Cloison de 50 mm

Cloison de 70 mm

Cloison de 100 mm

Extension d'ébrasement PREMIUM de 100mm à 280mm

Ebrasement PREMIUM
Un seul ébrasement pour 3 types de cloison, 50/70/100 mm
PREMIUM frame
One frame for three size of wall

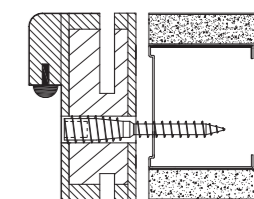

Vis à double filetage pour une fixation et un réglage rapide.

Screw with double threading for a fixation and a fast regulation

COTES DE RESERVATION BLOC PORTE								
centimètres	FLAT 73	FLAT 83	FLAT PFC 73	FLAT PFC 83	FLAT PFC 93	PREMIUM 73	PREMIUM 83	PREMIUM 93
Réservation en hauteur	209	209	209	209	209	209
Réservation en largeur	80,4	90,4	100,4	80,4	90,4	100,4
Cote hors tout cadre	80	90	79,4	89,4	99,4	79,4	89,4	99,4
Cote hors tout cadre	207,5	207,5	207,5	207,5	207,5	207,5	207,5	207,5
Cote hors tout avec couvre joint largeur	89,6	99,6	109,6	89,6	99,6	109,6
cote hors tout avec couvre joint hauteur	212,6	212,6	212,6	212,6	212,6	212,6

DIMENSION RESERVATION DOOR FRAME								
inches	FLAT 28,7	FLAT 32,7	FLAT PFC 28,7	FLAT PFC 32,7	FLAT PFC 36,6	PREMIUM28,7	PREMIUM32,7	PREMIUM36,6
Reservation in height	82,28	82,28	82,28	82,28	82,28	82,28
Reservation in width	31,65	35,59	39,53	31,65	35,59	39,53
Full dimension without architrave width	31,50	35,44	31,26	35,20	39,13	31,26	35,20	39,13
Full dimension without architrave height	81,70	81,70	81,70	81,70	81,70	81,70	81,70	81,70
Full dimension with architrave width	35,27	39,21	43,14	35,27	39,21	43,14
Full dimension with architrave height	83,70	83,70	83,70	83,70	83,70	83,70

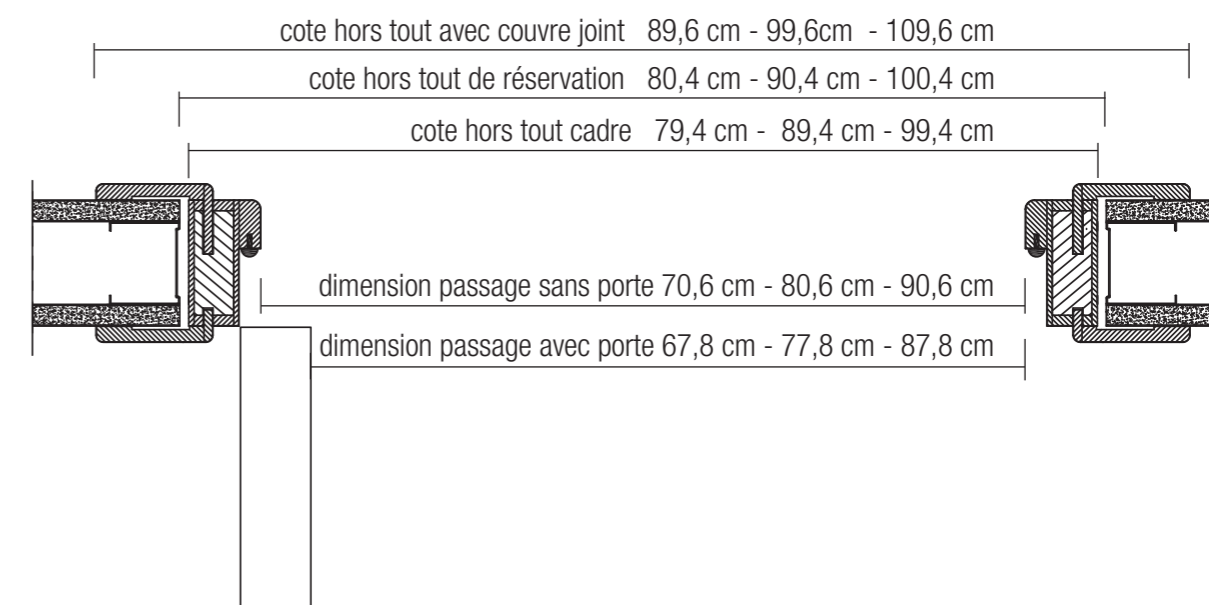

Données techniques

Technical data screen door

Collection PREMIUM

Collection FLAT

PREMIUM collection FLAT collection



Serrure réversible avec pêne en teflon et acier pour une fermeture silencieuse et la préservation du vernis de la gâche
Reversible lock with bolt teflon and steel for a silent closure and the conservation of the striking plate varnish

Joint de confort
Comfort joint

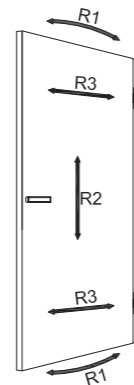

Ajustement horizontal et vertical de la porte
Horizontal and vertical door adjustment

Charnière invisible réversible
Reversible invisible hinge



Cache pour masquer les systèmes de réglages
Hiding place to mask the systems of adjustments

Toutes les clés des portes PREMIUM et FLAT sont ornées d'un gland

All the keys of the PREMIUM doors and FLAT is decorated with an acorn

CARACTERISTIQUES TECHNIQUES

centimètres	FLAT 73	FLAT 83	FLAT PFC 73	FLAT PFC 83	FLAT PFC 93	PREMIUM 73	PREMIUM 83	PREMIUM 93
Ebrusement pour cloison de 50,70 et 100mm	non	non	oui	oui	oui	oui	oui	oui
Huisserie à vernir pour cloison de 50 et 70mm	oui	oui	non	non	non	non	non	non
Charnière invisible réglable tridimensionnel	non	non	oui	oui	oui	oui	oui	oui
fiche réglable bidimensionnel	oui	oui	non	non	non	non	non	non
Serrure silencieuse	non	non	non	non	non	oui	oui	oui
Serrure magnétique, standard sur Liberto	non	non	oui	oui	oui	non	non	non
Pose en début de chantier	oui	oui	non	non	non	non	non	non
Pose en fin de chantier	non	non	oui	oui	oui	oui	oui	oui
Recoupable pour VMC	oui	oui	oui	oui	oui	oui	oui	oui
Joint de confort intégré	option	option	oui	oui	oui	oui	oui	oui
Joint balai sur support alu, vissé sous la porte	option	option	option	option	option	option	option	option
Serrure aspect argent à condamnation	option	option	option	option	option	option	option	option
Serrure 3 points	option	option	non	non	non	non	non	non
Extension murale pour mur de plus de 100 mm	non	non	option	option	option	option	option	option

TECHNICAL CHARACTERISTICS

inches	FLAT 28,7	FLAT 32,7	FLAT PFC 28,7	FLAT PFC 32,7	FLAT PFC 36,3	PREMIUM 28,7	PREMIUM 32,7	PREMIUM 36,6
Frame for three size of partitions 1,97 2,75 and 3,93 inches	no	no	yes	yes	yes	yes	yes	yes
Frame to varnished for two partitions 1,97 and 2,75 inches	yes	yes	no	no	no	no	no	no
Invisible hinges which have three dimensional adjustments	no	no	yes	yes	yes	yes	yes	yes
Turlupet pins for adjustment of the door in two direction	yes	yes	no	no	no	no	no	no
Silent lock	no	no	no	no	no	yes	yes	yes
Magnetic lock, standart on Liberto	no	no	yes	yes	yes	no	no	no
Settle at the beginning of the construction site	yes	yes	no	no	no	no	no	no
Implemented at the end of the construction site	no	no	yes	yes	yes	yes	yes	yes
Cut of bottom door to be conform whith VMC	yes	yes	yes	yes	yes	yes	yes	yes
Joint of integrated comfort	option	option	yes	yes	yes	yes	yes	yes
Silicone brush fitted an aluminium strip screwed under the door	option	option	option	option	option	option	option	option
Silver lock for toilet	option	option	option	option	option	option	option	option
security lock	option	option	no	no	no	no	no	no
Extension for wall of more than 39,37 inches	no	no	option	option	option	option	option	option

Données techniques porte coulissante

Technical data screen door

Collection PREMIUM

Collection FLAT

PREMIUM collection FLAT collection

DESCRIPTIF PORTE COULISSANTE

centimètres	FLAT 73	FLAT 83	FLAT 93	PREMIUM 73	PREMIUM 83	PREMIUM 93
Porte rive droite	oui	oui	oui	oui	oui	oui
Rail en applique	oui	oui	oui	oui	oui	oui
Habillage coulissant en applique	oui	oui	oui	oui	oui	oui
Habillage coulissant en caisson	oui	oui	oui	oui	oui	oui
Porte simple	oui	oui	oui	oui	oui	oui
Porte double	oui	oui	oui	oui	oui	oui

SCREEN DOOR DESCRIPTION

inches	FLAT 28,7	FLAT 32,7	FLAT 36,6	PREMIUM 28,7	PREMIUM 32,7	PREMIUM 36,6
Straight edge door	yes	yes	yes	yes	yes	yes
Rail in wall lamp	yes	yes	yes	yes	yes	yes
Dressing of outside wall screen door system	yes	yes	yes	yes	yes	yes
Dressing of inside wall screen door system	yes	yes	yes	yes	yes	yes
Simple door	yes	yes	yes	yes	yes	yes
Dual door	yes	yes	yes	yes	yes	yes



Habillage du caisson pour porte coulissante
Preparation of inside wall screen door system

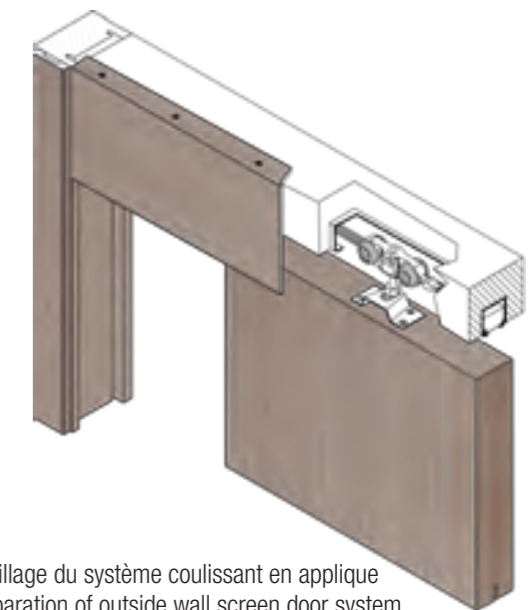

Habillage du système coulissant en applique
Préparation of outside wall screen door system
Rail en applique avec amortisseur avant / arriere
Rail with wall lamp with shock absorber before and back



Poignée cuvette et douille de tirage
Tubular opening handles



Poignée cuvette et serrure à condamnation
Tubular opening handle and lock with condemnation